

Auto Drain / Valve

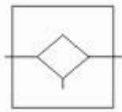

Symbol:



Technical Data

Model	AD400		
Bore No.	8A	10A	15A
Port size	PT1/4	PT 3/8	PT1/2
Medium	Air		
Operating pressure range	0~0.99MPa		
Proof pressure	1.5MPa		
Ambient temperature	-5~60°C(no freezing)		

How to Order



AD400

MODEL

8A

BORE SIZE
8A:PT 1/4
10A:PT 3/8
15A:PT 1/2

BSP

PORT THREAD
Blank: PT thread
BSPT: BSPT thread
NPT: NPT thread

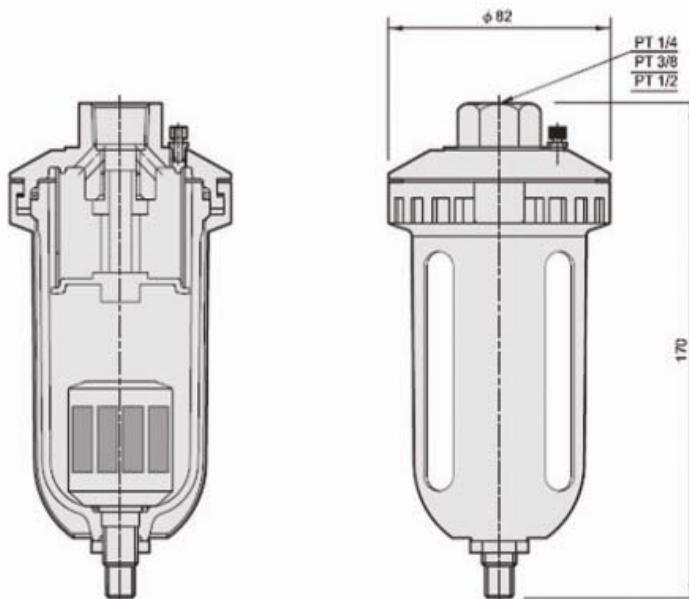

Auto Drain / Valve

Model	ADV-400-F	ADV-300-F	ADV-BC-M	ADV-400-GM
	ADV-400-M	ADV-300-M	ADV-AC-M	ADV-300-GF
Port size	1/8	1/8	1/8	1/8
Medium	Air			
Operating pressure range	0~0.99MPa			
Proof pressure	1.5MPa			
Ambient temperature	-5~60°C(no freezing)			



ADV-400-GM



ADV-300-GF



ADV-BC-M



ADV-AC-M



Dimensions (mm):

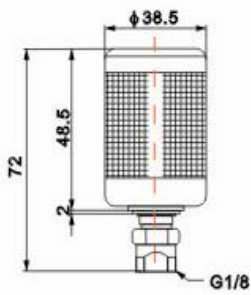

ADV-400-F

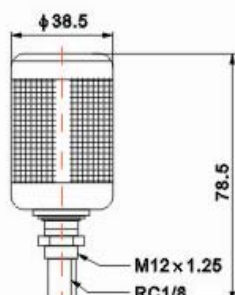

ADV-400-M

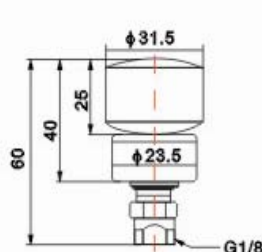

ADV-300-F

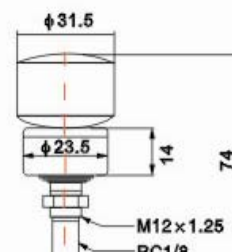

ADV-300-M

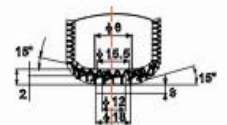

Auto Drain / Valve



ADV-400-F



ADV-400-M



ADV-300-F



ADV-300-M

Dimensions (mm):

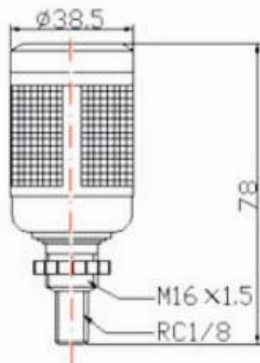

ADV-BC-M

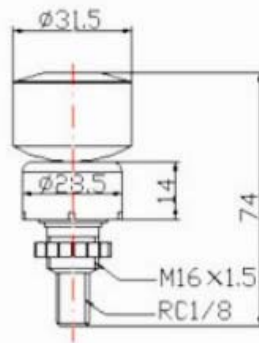

ADV-AC-M

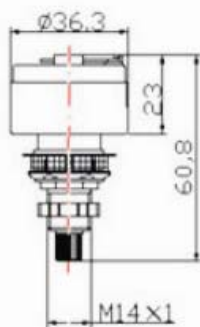
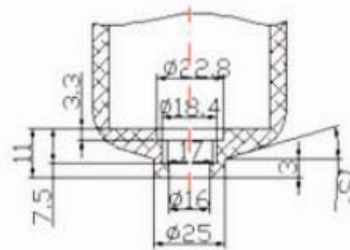

ADV-400-GM

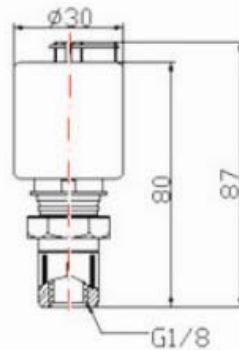

ADV-300-GF

